

Stock Room Supplies



WHERE VALUE IS ALWAYS DISPLAYED
www.econoco.com

CHROME METAL HANGERS

Reduces losses due to breakage. These 1/8" thick steel hangers are strong and will support heavy garments. Ideal for specialized departments within a store, for showrooms, trade shows, coat check operations in hotels, restaurants, theaters and more.

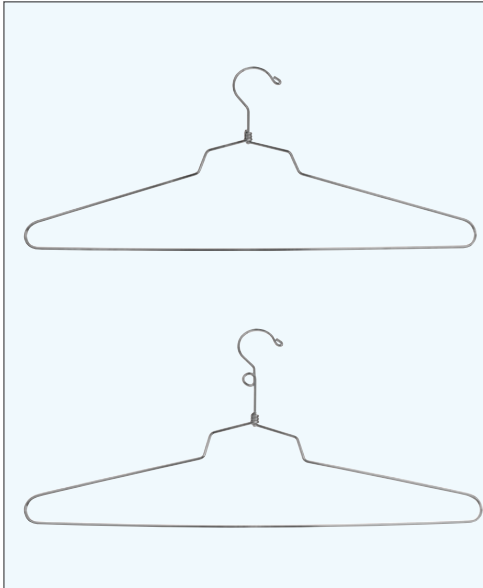

Dress and Blouse/Shirt Hanger with Swivel Hook

Children's

SLD/12 – 12" wide with Regular Hook

SLD/12-LH – 12" wide with Loop Hook

Teens

SLD/14-LH – 14" wide with Loop Hook

Womens

SLD/16 – 16" wide with Regular Hook

SLD/16-LH – 16" wide with Loop Hook

Mens

SLD/18 – 18" wide with Regular Hook

SLD/18-LH – 18" wide with Loop Hook

Oversized Garments & Outerwear

SLD/19 – 19" wide with Regular Hook

SLD/19-LH – 19" wide with Loop Hook

STEEL SPECIALTY HANGERS

Non-Slip Hanger with Swivel Hook for Blouses & Lingerie

Ideal for lightweight delicate apparel.

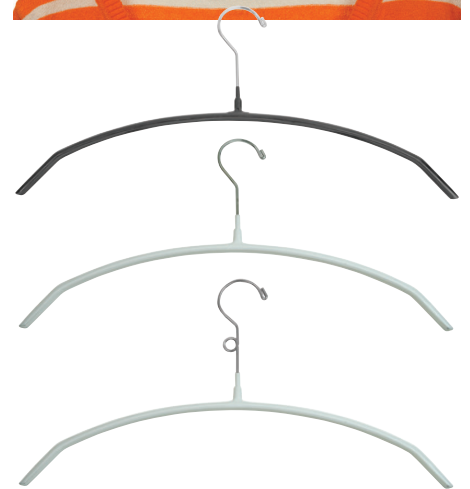

PC16/B-SW - Black with Regular Hook

PC16/W-SW - White with Regular Hook

PC16/W-LH - White with Loop Hook

16" wide. Epoxy covered wire hanger has non-slip feature that keeps garments secured to hanger.

Skirt Hanger with Swivel Hook

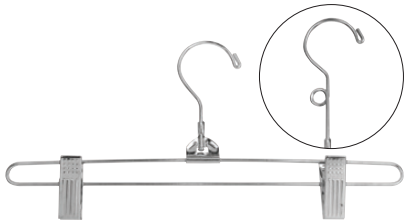

12" wide with two Vinyl Cushion Clips

SKT/12 – with Regular Hook

SKT/12-LH – with Loop Hook

Suit Hanger with Swivel Hook

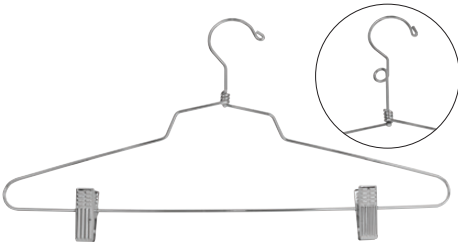

16" wide with two Vinyl Cushion Clips

SLC/16 – with Regular Hook

SLC/16-LH – with Loop Hook

Lingerie Hanger with Swivel Hook

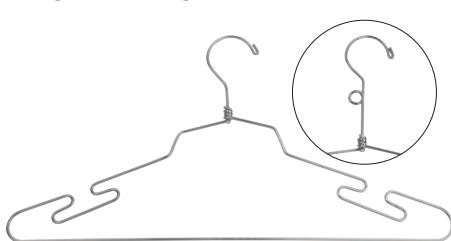

LIN/16 – 16" wide, with Regular Hook

LIN/16-LH – 16" wide, with Loop Hook

Steel Drop Attachment

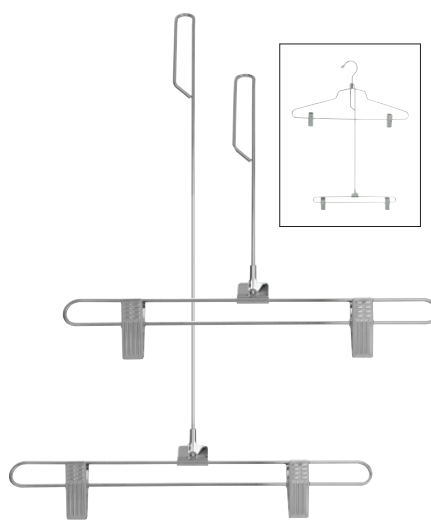

12" wide with two Vinyl Cushion Clips

DSA/9 – 9" drop

DSA/16 – 16" drop

Steel Diaper Pin Rod



DP/14 – 14" wide. Used to connect hangers with wire loops for transporting.

Slack Hanger



SPS/15 – Deluxe "S" Style Slack Hanger with Non-Slip Vinyl Sleeve – 15" wide

Bedspread & Drapery Hanger



SBD/22 – 22" wide

HANGER ACCESSORIES

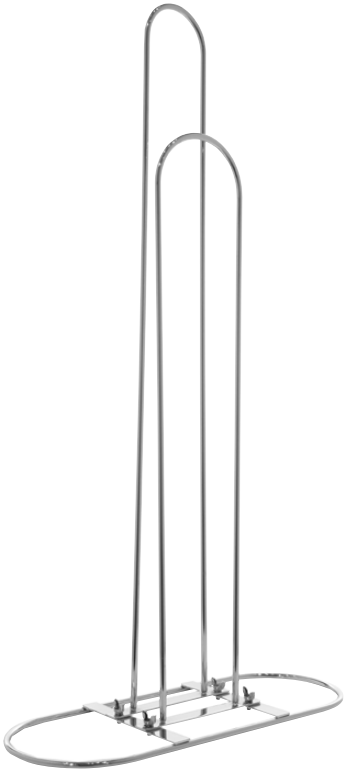

Hanger Stacker

item: **HS4**

Used by retailer to conveniently stack dress and coat hangers. Works with Wire Hangers, Wood Hangers & Plastic Hangers. 33"H x 18"L x 7"W. Chrome finish.



Hanger Retriever

item: **P48**

54" long. Has wood handle and shepards hook. Use the hanger retriever to get garments on hangers from hangrails beyond your reach. This affordable pole will neatly retrieve your garments that are stored high on the selling floor or in the stock room.

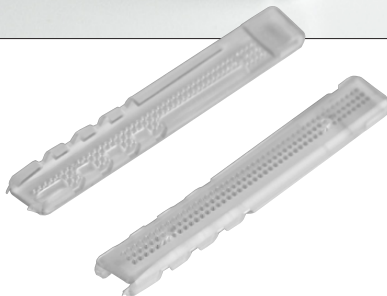

Non Slip Hanger Attachment

item: **AT4**

Attachment has grippers that conveniently snap directly onto plastic hangers to prevent garments from slipping off hanger. Used for light to medium weight garments. 4" long x 1/4" wide. Clear plastic.

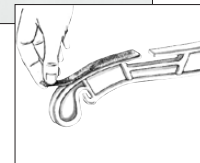

Pressure Sensitive Polyurethane Foam

item: **FP7**

Peel & stick foam strip prevents garments from slipping off hanger. Use 2 per hanger best used with light to medium weight garments. 4"L x 3/8"W. 1600 stickers per roll.

ROLLING RACKS



Both fold flat for easy storage.



The Economy Heavy Duty Collapsible Salesman's Rack

item: **RCS/2**

Great for use in a retail setting as a display. Uses plastic hexagonal rods in base. Polished chrome 1" diameter round tubing. 48" hangrail with two 12" pull out rods. Height adjusts from 54" to 65". 4" industrial ball bearing casters. Includes clips for hangrail storage and protective rubber bumpers.



Folds flat for easy storage.

Collapsible Salesman's Rack with Square Tubing

item: **RCS/4**

Polished chrome 1" square tubing. 48" hangrail with two 12" pull out rods. Height adjusts from 54" to 65". 4" industrial ball bearing casters. Includes clips for hangrail storage and protective rubber bumpers.

The Original Heavy Duty Collapsible Salesman's Rack

item: **RCS/1**

Designed for frequent heavy duty use. Uses steel hexagonal rods in base that adds stability and strength. Polished chrome 1" diameter round tubing. 48" hangrail with two 12" pull out rods. Height adjusts from 54" to 65". 4" industrial ball bearing casters. Includes clips for hangrail storage and protective rubber bumpers.

ACCESSORIES FOR ROLLING RACKS

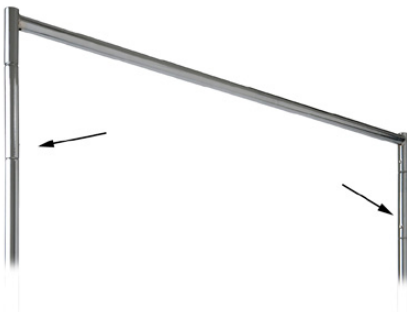

6" Height Extensions for Round Tubing Rolling Racks

item: **TA/6**

1" Diameter tubing easily slides into vertical posts on the **RCS/1**, **RCS/2** & **RCS/3** to add an extra 6" in height for longer gowns and coats. Chrome finish.



Display Screen/Shelf - item: **RCA/5**

Fits **RCS/1**, **RCS/2** & **RCW/4**.

Includes two(2) connecting brackets and one (1) stabilizing hook. Folded in half acts as a merchandise shelf. When opened, use as a display screen for exhibiting merchandise. Hangs on salesman's rack. Chrome finish.



Use as a base shelf.



Use as a Display Rack.

ROLLING RACKS



Single Hangrail Rolling Rack with Square Tubing Uprights

item: **K43**

1" square tubing frame. 60" long 1" diameter round hangrail. Height adjusts from 54" to 74". 4" industrial casters. Twin stretcher bars at bottom add strength and durability. Rack can hold up to 200 lbs of weight. Designed for heavy duty backroom use. Chrome finish.



Collapsible Salesman's Rack With Double Hangrail

item: **RCS/3**

Polished chrome 1" diameter round tubing. 48" hangrail with four 12" pull out rods. Height adjusts from 54" to 65". 4" industrial ball bearing casters. Includes protective rubber bumpers.



Economy Heavy Duty Nesting Z-Rack

item: **RZK/8**

Ideal for showrooms and warehouses. Racks can be nested together for easy storage. Heavy duty Z-base comes in three parts and is bolted together. Hangrail made of 1-1/4" round tubing and is 60 1/2" long. Rack is 66"W x 70" high. 6" industrial casters. OSHA orange base also available. Item: **RZK8RNG**

ACCESSORIES FOR Z-RACKS

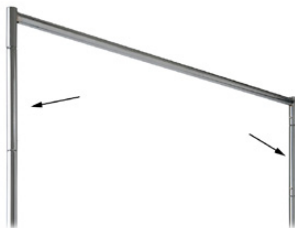

12" Height Extensions for Z-Racks

item: **RZE/12**

1-1/4" Diameter tubing easily slides into vertical posts on the **RZK/7** & **RZK/8** to add an extra 12" in height for longer gowns and coats. Chrome finish.



Add-On Hangrail for RZK/7

item: **RZH/60**

60" Long hangrail for when double capacity is needed. Chrome finish.



Plastic Garment Cover for RZK/8

item: **PT2464**

Includes two chrome uprights and a zippered bag to protect garments. The bag measures: 64"L x 24.25"W x 70"H.



Heavy Duty Nesting Z-Rack

item: **RZK/7**

Ideal for showrooms and warehouses. Racks can be nested together for easy storage. Heavy duty Z-base is a one piece construction. Hangrail made of 1-1/4" round tubing and is 58 1/2" long. Rack is 64"W x 68" high. 6" industrial casters.

POLY BAGS AND DISPENSERS



Transparent Polyethylene Garment Covers on Rolls

Superweight 1 mil thick covers feature heat-sealed shaped shoulders with hanger opening.

item: **U336**

Measures: 21"W x 36"L x 3"
Great for suits and jackets.
500 Bags per roll

item: **U354**

Measures: 21"W x 54"L x 3"
Great for jackets and coats.
333 bags per roll

item: **U372**

Measures: 21"W x 72"L x 8"
Great for gowns and formal wear.
250 bags per roll



3-Roll Polyethylene Dispensing Rack

item: **K30**

Will hold three rolls up to 26" in width. Bagging jack holds hanger with garment for easy use and adjusts from 39" to 68" high. Base is made of 1" square tubing. 29" wide x 14" deep allows for minimal floor space. Bagging jack contains convenient foot pedal for height adjustment. Perfect for backroom use in drycleaning or retail apparel stores. Chrome finish.

Replacement Jack For K30

item: **JACK30**



1 Roll Polyethylene Vertical Dispensing Rack

item: **K31**

Holds one roll of poly bags. Bagging jack holds hanger with garment for easy use and adjusts from 36" to 66" high. Spring loaded handle keeps last bag from falling. 12" wide x 18" deep allows for minimal floor space. Bagging jack contains convenient foot pedal for height adjustment. Perfect for under counter use. Chrome finish.

Replacement Jack For K31

item: **JACK30**



Bagging Jack with Round Base

item: **K32**

Bagging jack holds hanger with garment for easy use and adjusts from 36" to 66" high. Heavy weight 12" diameter base adds stability. Bagging jack contains convenient foot pedal for height adjustment. Perfect for under counter use. Chrome finish.

Replacement Jack For K32

item: **JACK32**

OVERLAP GARMENT COVERS

Overlap Garment Covers

Heavy-duty individual transparent covers are bound across the shoulders and down the front flap for added durability. Protect garments from being soiled while providing easy access. Tailored construction features heavy binding, reinforced hanger opening and extra-wide overlap for added protection. Perfect for storage, layaway, or customer take-home. 2 gauge crystal clear vinyl. 120 bags per carton.



item: **C72**
Measures: 24"W x 72"L
Closed bottom.
Great for gowns and long coats.



item: **C54**
Measures: 24"W x 54"L
Open bottom.
ladies coats or dresses, or
mens full length coats.



item: **C36**
Measures: 24"W x 36"L
Open bottom.
Great for mens suits and
womens pants suits,
short jackets or
childrens apparel.

SHOULDER COVERS

Shoulder Covers

Heavy-duty, crystal clear covers protect garments from getting soiled, while providing easy access. Tailored construction features heavy binding, reinforced hanger opening.

Item No	Size	Style	For Use With
U113	13" x 21"	1 Gauge	Ladies' Dresses, Blouses
		Sewn Seam	
N8X21	8" x 21"	2 Gauge	Ladies Dresses, Blouses
		Sewn Seam	
N9X24	9" x 24"	Sewn Seam	Ladies' Suits
N9X24M	9" x 24"	Sewn Seam	Men's Suits
N8X21X2	8" x 21" x 2"*	Sewn Seam	Ladies' Dresses, Blouses
N9X24X2	9" x 24" x 2"*	Sewn Seam	Ladies' Suits & Coats
FN8X21	8" x 21"	5 Gauge	Ladies' Dresses, Blouses
		Sewn Seam	
FE8X21	8" x 21"	Sealed Seam	Ladies' Dresses, Blouses

*Two inch gusset allows space for thicker wooden hangers.



PAPER CUTTERS



Single Tier Gift Wrap/Paper Cutter

Spring loaded cutting edge, electrostatic painted frame, holds 9" diameter roll. Can be mounted on wall, on counter or under counter use. These high-quality but affordable cutters work well with standard gift wrap or kraft paper. Dispenses smoothly and sharply. Ships knocked down for low freight cost. Includes rubber bumper feet and 3/4" screws for mounting.

item: **CT18**
Accepts 18" wide rolls.

item: **CT24**
Accepts 24" wide rolls.

item: **CT30**
Accepts 30" wide rolls.

item: **CT36**
Accepts 36" wide rolls.

SHOPPING BAG RACK



Shopping Bag Rack

item: **K39**
Great for department stores. Two piece construction. Round tubing faceouts with disc end. Square tubing 45" upright.

GARMENT STEAMER

SteamButler II



item: **ST400**

A lightweight, easy-to-use steamer that will produce a steady, high thrust continuous flow of steam within 30 seconds! Durable enough to stand up to daily in-store use. Maintenance Free – Just fill it and use it!

Removes wrinkles from a variety of items:

- All types of clothing,
- Upholstery,
- Draperies,
- Tableclothes and Linens

Specifications:

- One year limited warranty
- Item No: ST400
- 1350 watts of power
- Lighted on/off switch
- Auto safety shutoff
- 2.6 liter, shatter-proof, easy view water bottle
- 66" long hose with comfort-grip handle
- (4) easy-roll casters
- Solid Brass fittings & heating element
- Solid Aluminum hanging pole
- ETL certification

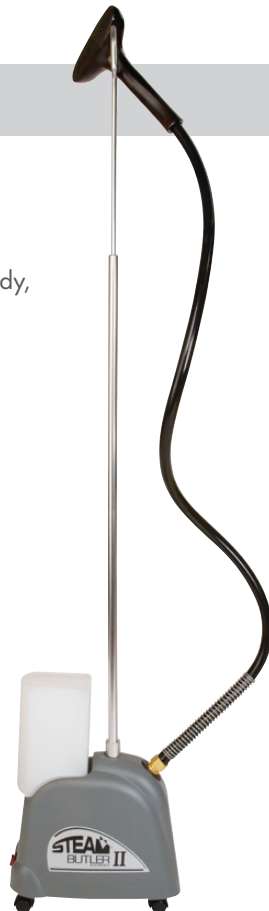

FOLDING BOARDS

Acrylic Folding Boards

Folding board made of sturdy acrylic with cutout handle allows your merchandising staff to refold sweaters and tops perfectly every time. Keeping your folded garments uniform results in a more attractive display of your inventory.



Small

item: **HP/SFB-S**
8-1/2"W x 11"H

Medium

item: **HP/SFB-M**
10"W x 12"H

Large

item: **HP/SFB-L**
11"W x 12"H

